

رؤية
VISION
2030
المملكة العربية السعودية
KINGDOM OF SAUDI ARABIA

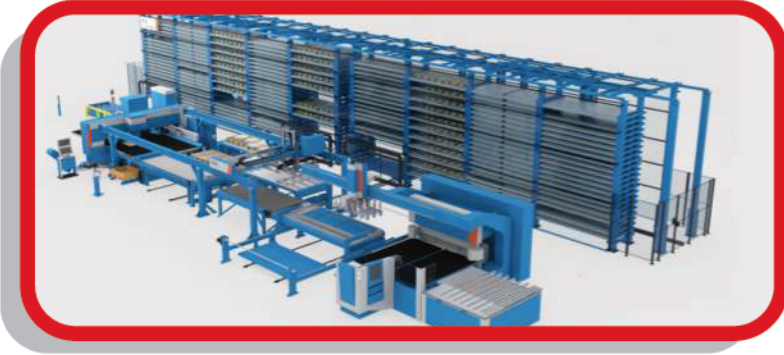

TISENG GROUP.

PRODUCT CATALOGUE



2024
V 07

The Power To Be Your Best Supplier

www.tiseng.com

INDEX

WHY TISENG.
PARTNERS
ABB ROBOTICS.
LASER CUTTING.
WATERJET CUTTING.
PLASMA CUTTING.
HYDRAULIC SHEAR.
INDUSTRIAL KNIVES.
CUTTING AND GRINDING DISCS.
BAND SAW MACHINE.
PUNCHING MACHINE.
PUNCHING TOOLS.
PLASMA AND LASER PARTS.
3 POINT PRESS BRAKE.
PRESS BRAKE.
ELECTRIC PRESS BRAKE.
MARKING MACHINES.
SPOT WELDING.
STUD WELDING.
BUSBAR PUNCHING.
BUSBAR BENDING.
ROLLFORMING LINES.
PLATE, PIPE AND BEAM
PROCESSING.
PLATE BENDING MACHINES.
PLATE ROLL MACHINE.
ALUMINUM FABRICATING.
SHOTBLASTING MACHINES.
WASHING MACHINES.
TREATMENT CHEMICALS.
POWDER COATING LINES.
POWDER COATING MACHINES.
BURNERS.
FILTERS.
HANDLING SYSTEMS.
TESTING EQUIPMENT.
POWDER COATING
SHEET METAL TESTING.
WELDING MACHINES
CORROSION TESTING.
MATERIAL TESTING.
UNIVERSAL TESTING MACHINES.
FURNITURE TESTING MACHINES.
HARDNESS TESTING MACHINES.
VISCOSITY METERS.
LABORATORY OVENS AND
CHAMBERS.
ARKAZ ENGINEERING FACTORY.



Why Tiseng

Provides integrated solutions in machinery and surface finishing. From the very beginning of processing with materials, going through fabrication and quality management, we professionally meet and exceed all the requirements and expectations.

Contacts

Tiseng Group Co .

www.tiseng.com

info@tiseng.com

Contact name :ABD EL-RAZEK EL-SEIDY

Saudi Arabia: (+)966506112322

Egypt : (+)201111621633

H.Q.Canada: (+)14509340871

PARTNERS



ABB robotics: abb.com/products/robotics

ABB is a leading supplier of industrial robots, modular manufacturing systems and service.

A strong solutions focus helps manufacturers improve productivity, product quality and worker safety.



Affri: <http://www.affri.com/>

Since 1954 AFFRI® has been producing Hardness tester where the force is generated by load cells instead of traditional dead-weight loads and elevating screws.

Combine this technology with innovative components and the result is the unique AFFRI SYSTEM®



Boschert: <http://www.boschert.de/>

The enterprise Boschert GmbH + Co KG established its international reputation through its notching and punching machine program and is well-known to every sheet-metal working company.



Prima Power www.primapower.com/en

Prima Power is a leading specialist in machines and systems for sheet metal working.

Prima Power is the Machinery Division of Prima Industrie Group.



COIVER: <http://www.coiver.com>

This is our Italian partner for designing and fabricating of complete powder coating lines. The coating line includes coating booth, drying oven, curing oven and conveyors



Gizelis: <http://www.gizelis.gr>

Gizelis S.A. was founded in 1968, specializing in the manufacturing of machines for the sheet metal industry. In 2004 Gizelis S.A. formed a strategic alliance with German company Boschert GmbH.

PARTNERS



GLOBE COMPANY ITALY:
<http://www.globeabrasives.com/>
Grinding and cutting discs since 1961



Lorenzon
<http://www.lorenzoni.com/>
Lorenzon has been manufacturing blades since 1933 and it has become a synonym of quality and professionalism in the processing of metals throughout the years.



PLASMA POINT SR:
<http://www.plasmapoint.com/>
PLASMA POINT SRL was set up in 1988 as producer of torches and spare parts for plasma cutting systems, accessories for the Laser CO2 cutting machines and as reseller of CO2 optics.



PASS :
<http://www.pass-ag.com/>
PASS Stanztechnik AG is a partner of the sheet-metal processing industry.
Since 1982, PASS is a specialist in building CNC punching tools for punching machines



Pei:
<http://www.pei-point.com/>
Started in Italy Since 40 years, trade mark PEI has been present on the international market resistance welders producing: Pedestal and pneumatic rocker arm spot welders, Bench spot welders, Seam welders and 3 phase d.c. spot-projection welders.



PIEMME:
<http://www.pm-eng.info/>
We have been constructing automatic punching and profiling lines for over 35 years.
Each roll forming line is designed and constructed based on the requests of the client according to his profile

PARTNERS



PICOT:

www.ambpicot.com

By blending know-how developed over the past 100 years with cutting-edge technology, Amb Picot can offer its customers rolling and forming tools specially designed for their applications.



POL-EKO-APARATURA:

<http://polekolab.com>

From Poland to the world, POL-EKO-APARATURA has been present in the market since 1990.

POL-EKO-APARATURA offers: BOD Incubators (ST), Laboratory refrigerators, Thermostatic boxes, Laboratory freezers, Laboratory incubators, Cooled incubators, Drying ovens, Laboratory sterilizers, Climatic chambers, Photoperiodic and Phytotron system.



SISMA:

www.sisma.com/en

Design and produce innovative systems and solutions, for those who manufacture and create, using the following technologies: precision micro mechanic systems, lasers and additive manufacturing (3D), leveraging the skills and experience accrued over time in different fields and application processes.



SAMES Technologies:

www.sames.com

SAMES was created in 1947 to manufacture and market electrostatic coating equipment. All your needs of manual and automatic coating machines and coating robots



ScanTool:

www.scantool.dk/en

At scantool we manufacture a wide variety of solid industrial machines reflecting many years of experience and knowledge since 1961



MG:

www.tronzadorasmg.com/

Founded in 1972, Tronzadoras MG designs and manufactures a full range of band and circular sawing machines for steel and aluminum profiles are. All machines are manufactured according to the CE directives.

PARTNERS



HBS WELDING:

<https://hbs-info.com/>

HBS is a global leader in the development and production of innovative welding, fastening and joining equipment and systems.



DAVI:

<https://www.davi.com/>

Davi was established in the 60's and today is the largest manufacturer of plate and angle rolls in the world. Davi's research and manufacturing facility is located in four office buildings.



STIERLI-BIEGER:

<https://www.stierli-bieger.com/>

Stierli-Bieger AG designs and builds universal horizontal bending and straightening machines, turning devices and storage systems.



EUROTRANSIS:

<https://eurotransis.com/>

Manufacturer of internal logistics products Eurotransis is a metal mechanical industry with over 26 years of international experience in the realm of maintenance



BLASER:

<https://blaser.com/>

For three generations, the Blaser name has stood for sustainable leadership and values. Our family company culture has a tradition that we now uphold as a global player as well. Our customers not only want cutting fluids, but also need a competent and dependable partner to help optimize their machining processes.



ALMIG:

<https://www.almig.de/en>

ALMiG stands for Automatic Air Pumps (Automatische Luftpumpen) - Made in Germany and is one of the leading system suppliers in compressed air technology. We stand for decades of experience in top products in the compressed air industry.

ROBOTICS

About

ABB is a leading supplier of industrial robots, modular manufacturing systems and service. A strong solutions focus helps manufacturers improve productivity, product quality and worker safety. ABB has installed more than 200,000 robots worldwide



ABB and robot based automation for Metal Fabrication

ABB has the system-competence to offer turn-key solutions. Together with our strong partners we provide specialized process and application know-how.

ABB can always offer you the right solution to control processes and hereby enhance quality.

Metal fabrication processes:

Cutting



Forming



Welding & Joining



Inspection & Measuring

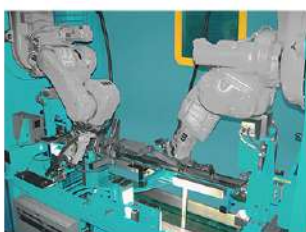

Surface Treatment & Finishing



Material Handling



BOSCHERT



About

The enterprise Boschert GmbH established its international reputation through its notching and punching machine program and is well-known to every sheet-metal working company. Established in 1946, Germany, Boschert is famous for Hydraulic copper bar punching machines.



PLASMA CUTTING

Standard equipment

- Rigid Heavy Duty Construction, with separate table, ensuring very low level of vibrations.
- Flat Bed design table with portal type bridge
- Heavy duty guiding system with linear guides for both X & Y axis.
- Transmission systems through rack and pinion for all axes.
- Movement control with latest technology AC servo system & planetary gears, achieving speed of 20m/min.
- Safety limit switches for all axis.
- Wide range of selection of plasma cutting sources. (high definition or conventional ones).
- Selection between manual or automatic gas control console.
- Possibility for option oxygen torch.



Ergo-Cut 3150 Compact series with highly exact guidance



Punching Machine CombiCut
The Plasma Punch combination



Scan the code For technical info

BOSCHERT

PUNCHING MACHINES

From single-piece production to large series, Boschert offers a selection of different punching machines for your sheet metal.

ECCOLINE

All ECCOLINE machines are equipped with 28 t punching pressure (40 t on request) and Trumpf Tooling system.



Scan the code For technical info



EccoLine Punching Machine
A must for every sheet metal Co.

MiniPress

With a small footprint, the Mini Press punching machine has become a popular entry-level machine not only among window manufacturers.



Scan the code For technical info



MiniPress Punching machine
Small, compact, strong.

CompactEVO

Stepless 360 degree rotation of all tools up to 105 mm diameter using brushless DC motors and pneumatic indexing of Revotools.



Scan the code For technical info

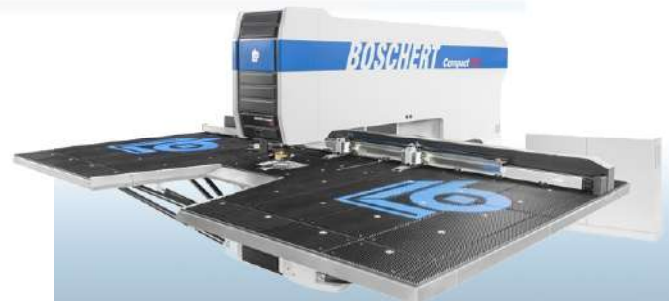

CompactEVO
Design meets experience



BOSCHERT

PROCESS COPPER

CUPROFI COPPER BAR PUNCHING MACHINE

CNC controlled punching machine with up to 8 Heads, tooling system AMADA (station B)



Scan the code For technical info



CUPROFI
COPPER BAR WORK MADE EASY

HYDRAULIC COPPER BAR PUNCHING MACHINE TYP CU-WK

CNC controlled punching machine with 5 Heads tooling system AMADA (station D)



Scan the code For technical info



CU-WK II
Th copper bar machine



PASS



About

PASS Stanztechnik AG is a partner of the sheet-metal processing industry. Since 1982, PASS is specialized in building CNC punching tools for punching machines.



TRUMPF TOOLING SYSTEM

PASS Stanztechnik AG has many years of experience with the TRUMPF system. Over the past few years, our position as the expert for special tools has been expanded and we can now be considered the world leader in that field.

Scan the code For technical info



SALVAGNINI TOOLING SYSTEM

PASS Stanztechnik AG has more than 18 years of experience with the Salvagnini system. Over the past few years, our position as the specialist for special tools has been expanded, and we can now be considered the world leader in that field.

Scan the code For technical info



THICK TURRET TOOLING SYSTEM

PASS Stanztechnik AG has many years of experience with the THICK TURRET system. Over the past few years, our position as the specialist for special tools has been expanded, and we can now be considered the world leader in that field.

Scan the code For technical info





PLASMA POINT



About

Plasma Point Poland is a renowned supplier of consumables for welding processes, spot welding, resistance/electric welding, gas, laser and plasma cutting to almost all the leading manufacturers of this type of equipment.



CONSUMABLES FOR LASER AND WELDING MACHINE

PLASMA POINT SRL was set up in 1988 as producer of torches and spare parts for plasma cutting systems, accessories for the Laser Co2 cutting machines and as reseller of Co2 optics.

We supply:

1. Consumables, accessories and optics for laser Co2 cutting machines.
2. Welding torches suitable for the most important brand names in the welding market.
3. Global Torch® cutting torch which can retrofit countless power sources up to 120 Amps.
4. Cutting torches for plasma cutting machines.
5. Accessories for waterjet.
6. Cutting tips and Accessories for oxyfuel cutting machines.



Scan the code For More info



Laser marking



Laser engraving



Laser welding

SISMA



About

Founded in 1961, SISMA can rely on the great experience it has acquired building over 130 models of machinery for the automatic production of gold chains. Today in the forefront of the development of laser systems, SISMA has been able to extend its know-how to the creation of production solutions for marking, welding, cutting, engraving and additive manufacturing.



Laser marking and engraving for the industrial field

Our range of machines for laser marking and engraving for the industrial field: integratable sources, compact table desktop systems, stand-alone systems with support base and work stations.



BSP, -3axis laser marking and engraving system



LWS-A, Laser marking stations with three axes



BSP PICO laser marking engraving machine

Laser welders for the industrial field

Our range of laser welders for industrial applications: integratable sources, manual and automatic systems for repetitive work cycles.



SWA 300F/450F, laser welding, mold maintenance system



SL 300/150, integratable source for laser welding



SWA 300/150, semi-automatic laser welding



PM PROFILES



About

We have been constructing automatic punching and profiling lines for over 35 years.

Each roll forming line is designed and constructed based on the requests of the client according to his profile

SPECIAL COLD FORMING PROFILE PRODUCTION FOR:



Agriculture

Creation of profiles that are used in the primary sector, such as grape cultivation, irrigation, greenhouse cultivation, silos, animal feed systems and others.



Air

Creation of profiles for air flow generation and management systems, such as fans and air filters, air conditioners, air generation machines, pipes, ducts and more.



Domestic Appliances

Creation of profiles that are used in household appliances such as kitchens, boilers, stoves, refrigerators, dishwashers, washing machines, up to the creation of broom handles, clothes racks and irons.

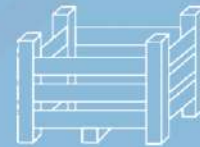

Storage systems

Creation of profiles for storage systems such as light shelving for supermarkets or automatic warehouses, metal containers, locker rooms, mezzanine systems.



HBS



About

HBS is formed more than 40 years ago in Germany. HBS provides a full range of pad and stud welding systems and accessories augments our product range of manual units, semi-automatic systems, as well as fully automated CNC machines.



Welding Units

Our award-winning machines impress with more than 40 years of innovation, robustness in practice and maximum ease of operation. They deliver outstanding welding results and set standards in their classes.

Our equipment technology is of course completely "Made in Germany", from in-house development to production.



Visar 650
Tough! Single phase inverter
Compact, lightweight with
high protection class (IP 44)



CPW-Series
Entry-level CNC stud
welding machine with



MPW-Series
High performance CNC stud weld-
ing machine (with up to 4 welding
heads)

Scan the code For More info





HBS

Welding Guns

Our tried and tested welding guns enable the highest possible consistent welding quality due to special design. They impress with their ergonomics, compactness and user-friendly handling. They can be variably adapted to all welding tasks by using the appropriate accessories.

C 06-3	C 08	CA 08	CI 03
<ul style="list-style-type: none"> • Easy handling • No setting for lift and spring pressure • Aluminium to M4 (#8) 	<ul style="list-style-type: none"> • All-rounder also used for welding galvanised base material • Aluminium to M4 (#8) 	<ul style="list-style-type: none"> • Used to avoid rear side marking on thin sheets • Aluminium to M6 (1/4") • Brass to M4 (#8) 	<ul style="list-style-type: none"> • Especially suitable for welding of cupped head pins (HVAC)
CA 08	A 12	A 12	A 12-FL
<ul style="list-style-type: none"> • Entry-level version used for SC welding without length compensation 	<ul style="list-style-type: none"> • Small gun with easy set-up for SC welding • Length compensation (stable welding results) 	<ul style="list-style-type: none"> • Compact gun with easy set-up • Length compensation (stable welding results) 	<ul style="list-style-type: none"> • Simple set-up of the gun without length compensation

Accessories

Chucks, ceramic grips, leg assemblies, ground clamps, bending devices, torque testing devices, etc.

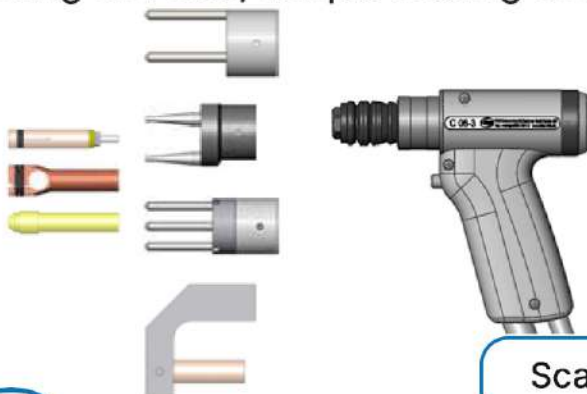

Scan the code For More info



PICOT



PICOT

About

By blending know-how developed over the past 100 years with cutting-edge technology, Amb Picot can offer its customers rolling and forming tools specifically designed for their applications.



Plate Bending Machinery

By blending know-how developed over the past 100 years with cutting-edge technology, Amb Picot can offer its customers rolling and forming tools specifically designed for their applications.

Product development is based on four key requirements:

Reliability, quality, ease of use and efficiency.





DAVI

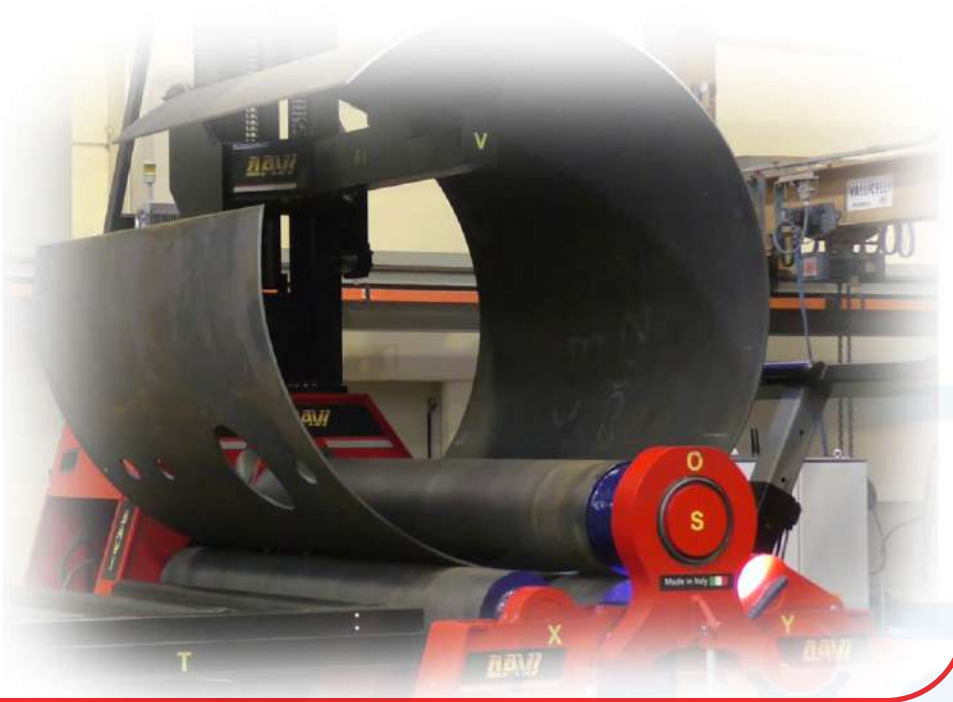

About

Davi was established in the 60's and today is the largest manufacturer of plate and angle rolls in the world. Davi's research and manufacturing facility is located in four office buildings.

Davi Plate Rolling Machinery

DAVI Plate Rolls portfolio includes 3 and 4 roll machines (both in horizontal and vertical configuration) with a thickness capacity up to 300 mm and width up to 6 m. These machines are suitable for any type of application. Special configuration such as Vertical Press Roll and Pre-Stressed Plate Roll are available upon request. DAVI standard solution includes digital Roll-by-Wire and Servo-Tronic® parallelism (patented), in order to grant the best result in terms of repeatability and accuracy. DAVI Plate Rolls can be equipped with the most user-friendly automation including DG-Gauge radius measurement control capable of supporting the operator on the control of the radius.



3 ROLL PLATE ROLLING MACHINE



Four Roll Plate Bending Machine



Pipe rolling machines

MG



About

Founded in 1972, Tronzadoras MG designs and manufactures a full range of band and circular sawing machines for steel and aluminum profiles are. All machines are manufactured according to the CE directives.



Aluminum Fabrication Machinery

Our Aluminum Fabrication machines have a wide range of Varieties and Specifications SINGLE BLADE SAW, AUTOMATIC MITER SAW, AUTOMATIC SAW, AUTOMATIC CUTTING & DRILLING, DOUBLE MITER SAW, MACHINING CENTERS, COPY ROUTERS, END MILLING MACHINES, PRESSES, VACUUM CLEANERS, POSITIONING SYSTEMS, CRIMPING MACHINES, ASSEMBLY TABLES



Scan the code For More Models and Technical info

SHOOT BLASTING

Shoot Blasting Machines



Shot blasting machines for mechanical sector such as:

- Hanger type shot blasting machine provided with hook or hoist.
- Continuous feed – O-ring overhead rail shot blasting machine provided with hook
- Tumbling steel belt shot blasting machine.
- Roller conveyor – pass-through type shot blasting machine for sheets/plates, -section bars and composed structures.
- Continuous feed – tunnel type – mesh-belt shot blasting machine for metallic parts.
- Roller conveyor – pass-through shot blasting machine FOR GAS BOTTLES/CYLINDERS
- Continuous feed shot blasting machines for pipes, bottles/cylinders and cylindrical parts.
- Shot blasting machine for descaling of wire, bars and billets.
- Continuous feed – pass-through – hanging load type shot blasting machine
- mod. GTU Turbine shot peening machine





STIERLI BIEGER

About

Stierli-Bieger AG designs and builds universal horizontal bending and straightening machines, turning devices and storage systems. The first bending machine was produced in 1936 and has undergone continuous development ever since.

Today Stierli-Bieger AG is a world market leader in horizontal bending and straightening machines.



Horizontal bending machines

Areas of application

BENDING:

- bend sheet metal.
- Bending busbars.
- Bending profiles.
- Bending flat bar.
- Metal Straightening with Straightening Machines.
- Radial bending.
- Bending round or square pipes / pipe machining
- Automatic re-bending.
- Bending from two sides (without turning).
- Heavy bending work.
- Narrow bends or bends with long leg length.
- Bending solid material - round, square, rectangular.
- Bending pipe clamps.
- Forming tools for series production (embossing tools).
- Bending with an angle greater than 90° .
- Special tooling.
- Bending on the flat side (edge).

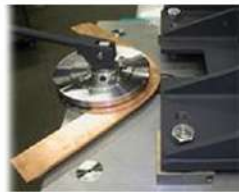
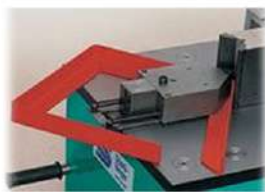



SAMES



About

SAMES was created in 1947 to manufacture and market electrostatic coating equipment. All your needs of manual and automatic coating machines and coating robots.



MANUAL SPRAY GUNS

Since 1925, Sames supplies to the industrial finishing industry a large range of paint spray guns, with or without electrostatic effect: our range includes all technologies for any paint jobs (HVLP paint guns, Airmix® or air assisted airless® paint guns, Airless® sprayer). Our equipment are designed for any industrial professional projects, from the automotive to the wood.

AUTOMATIC GUNS

Sames offers to the industrial finishing market a large range of automatic spray guns for liquid paints or powders, with or without electrostatic effect. Our guns offer high performance and fine atomization for exceptional finish quality. Maintenance and cleaning are reduced for high productivity and paint savings.

POWDER COATING MACHINES



SAMES

AUTOMATIC INSTALLATIONS



AUTO COLOR MEDIUM PRESSURE COLOR CHANGE SYSTEM

The SAMES KREMLIN Auto Color Medium Pressure Color Change System is an automated paint dispense system available in 4 to 19 color versions.



Ino Bell is ideal to coat large or fan surfaces

This sprayer applies different powders with a thickness consistency inferior to 5 microns.



Electrostatic rotating powder bell

Thanks to its perfect finishing, high transfer efficiency and with its large and flexible spraying patterns



Automatic powder sprayer

Auto-Mach-Jet provides coating performances, good penetration of the paint spray, ease of cleaning, simplicity of use in order to allow you increasing your productivity and change colour even faster!



POL-EKO



POL-EKO
Perfect Environment

About

We are your partner in lab analysis and technological processes.

Our wide range of products, professional solutions will suit the most demanding customers.

We remain open to assist in choosing the right product for your needs, as well as to provide you with customized solutions.



THERMOSTATIC EQUIPMENTS

- BOD Incubators (ST)
- Laboratory refrigerators
- Thermostatic boxes
- Laboratory freezers
- Laboratory incubators
- Cooled incubators
- Drying ovens
- Laboratory sterilizers
- Climatic chambers
- Photoperiodic and Phytotron system



Laboratory refrigerators are equipped with a cooling system and can provide a stable temperature between 0°C ... +15°C.



Cooled incubators (ST) can provide a stable temperature between +3...+70°C regardless of ambient conditions.



Drying ovens are designed to provide high temperatures up to 300°C.



Laboratory freezers can freeze and store frozen samples.

EUROTRANSIS



About

We are manufacturer of internal logistics products Eurotransis is a metal mechanical industry with over 26 years of international experience in the realm of maintenance



Rollers manufacturers

EUROTRANSIS manufactures all kind of rollers, in a high percentage of cases, the requirements of the project. If a development of a specific roller is needed, don't hesitate to send us the specifications in order to present you an attractive offer. In addition, rollers are designed and manufactured with the first qualities of the following materials: PVC, steel, aluminium, stainless steel, painted or zinc-plated steel.

Conveyors manufacturer

EUROTRANSIS is a manufacturer of conveyors that has specialized in manufacturing of processes, providing serial products such as roller, belt and chain conveyor, picking lines, integrators and sorting conveyor, and other complements like turn, tilt and lift tables...always following ISO9000 norm, regarding specifications, design and tolerances.

Componenets

EUROTRANSIS is a manufacturer of a high quality component of rollers conveyors .





PRIMA POWER



About

Prima Power is a leading specialist in laser and sheet metal working technology, and this is what we make for you every day and everywhere.

We are a leader in laser and sheet metal fabrication machines with a strong know-how in mechatronics, optoelectronics, automation, and software.

2D LASER CUTTING MACHINES

Prima Power 2D laser product range covers every production need,



LASER GENIUS+



LASER GENIUS

3D LASER CUTTING MACHINES

Laser cutting. The most flexible tool ever.



LASER NEXT 2141



RAPIDO



LASERDYNE® 795



PRIMA POWER

BENDING

MORE PRODUCTIVE MACHINES, NEW AUTOMATION SOLUTIONS.

Panel Benders
Press Brakes
Robotic Bending Cells



BCE SHARP



FBE FAST BEND

PUNCHING, SHEARING & COMBI

VERSATILE SOLUTIONS FOR YOUR NEEDS

Punching and Laser Cutting combined machines
Punching and Shearing combined machines
Punching machines



SCANTOOL



About

Scantool A/S is a sales company, which was founded in 1980 by Jens-Martin Nielsen. Scantool has the widest range of products within Scantool Group, and it is sold both national and international. The products are manufactured by Scantool Group at our production in Brovst in Denmark and in Poland.



SCANTOOL have a wide range of products

GRINDING & POLISHING

- Wet stone grinders
- Workshop grinders
- Double ended bench grinders
- Polishing machines



BELT GRINDERS

- Light duty belt grinders
- Workshops belt grinders
- Industrial belt grinders
- Vertical belt grinders
- Aluminum belt grinders
- Floor grinders



PIPE NOTCHER

- Pipe notchers with motorbrake
- Pipe notching with belt grinder
- ALMI-Universal pipe notchers



BARTELS



BARTELS
ONLINE SHOP

About

Existed since 1938 and are a family business with tradition in the third generation in the heart of Schleswig-Holstein. For years, we have been one of the leading manufacturers of storage equipment, which is sold via a classic sales force and a European network of agents.



SHELVING SYSTEMS

PANEL STORAGE

- Flat pallet magazine
- Drawer shelves for sheet metal
- Vertical panel storage

SHELVING

- File shelves
- Screw shelves
- Shelves

MORE SHELVES

- Shelves for special goods
- Accessories for shelves for special goods

WIDE-SPAN RACKS

- Wide-span racks
- Accessories for wide-span racks

DRAWER SHELVES

- Heavy-duty racks
- Tool and material racks

LONG GOODS STORAGE

- Cantilever racks
- Long goods pallets
- Long goods drawer shelves
- Roll-off shelves
- Vertical shelves
- Honeycomb racks

PALLET RACKS AND PULL-OUTS

- Support drawers
- Bottom drawers
- Hanging drawers
- Pallet rack



BLASER

Blaser.
SWISSLUBE

About

For more than eight decades, Blaser Swisslube has been reputed for dependable first-class products that are human-compatible and environment-considerate. High-performance metalworking fluids, CNC process optimization, and support services.



WATER-MISCIBLE FLUIDS

Our well-balanced product line offers you optimal flushing and cleaning, as well as unparalleled machining compatibility.

Blasocut
VASCO
B-COOL
Grindex
Synergy
Synergy DWS



Scan the code For More info



CUTTING OILS AND GRINDING OILS

The best grinding oil has perfectly balanced lubricating and self-sharpening characteristics

Blasogrind
Blasomill
Vascomill
Vascomill MMS



Scan the code For More info



GLOBE



About

We offer professional products improving user comfort and performance, thus contributing to competitiveness, safety and satisfaction of our partners and decreasing production costs. Support customers by developing new, reliable, innovating and quality solutions. Quick deliveries and efficient after-sales support.



CUTTING

FLAT THIN CUTTING WHEELS
FLAT STANDARD CUTTING WHEELS
FLAT STANDARD CUTTING WHEELS
DEPRESSED CENTER STANDARD CUTTING WHEELS
CUTTING WHEELS $\varnothing > 230\text{mm}$

COMBINED CUTTING, GRINDING

COMBINED CUTTING
COMBINED CUTTING
PIPELINER

GRINDING

DEPRESSED CENTER GRINDING DISCS FOR GRINDING
FLAT GRINDING DISCS FOR FRONT GRINDING
FLEXCELLENCE & FLEXCELLENCE EXTRA
TURBOTWISTER



FLAP DISCS

FLAP DISCS WITH FIBERGLASS SUPPORT
FLAP DISCS WITH PLASTIC SUPPORT

Scan the code For technical info





ALMiG

ALMiG Compressor Systems

About

ALMiG stands for Automatic Air Pumps (Automatische Luftpumpen) - Made in Germany and is one of the leading system suppliers in compressed air technology. We stand for decades of experience in top products in the compressed air industry.

PISTON COMPRESSORS

Our units are used in the low, medium or high pressure range (up to 400 bar) - and oil-free units are also available. ALMiG supplies you with piston compressors that are specially designed for the respective area of application.



SCREW COMPRESSORS

In the field of screw compressors, ALMiG is probably the manufacturer with the most extensive product range. Thanks to the clever modular system, approx. 90-80 % of all compressor components in a certain kW class are the same.



SCROLL COMPRESSORS

Scroll compressors operate extremely smoothly, resulting in a very low noise level. The %100 oil-free compressed air produced by scroll compressors makes them the ideal solution for highly sensitive applications and the low noise level means they can be installed directly where the high quality compressed air is needed.





ALMiG

CENTRIFUGAL COMPRESSORS

The special field of application of the DYNAMIC turbo compressors is mainly in the medium to large industrial sector of the petrochemical, refinery, steel and automotive industries - in short, everywhere where a consistent and highly reliable compressed air supply with 100 % oil-free compressed air is required - and this particularly economically.



COMPRESSED AIR TREATMENT

To ensure optimum use of compressed air, it should be dry, clean and sometimes oil-free. Reason enough to pay individual attention to the properly matched compressed air quality.



RAILWAY COMPRESSORS

To ensure optimum use of compressed air, it should be dry, clean and sometimes oil-free. Reason enough to pay individual attention to the properly matched compressed air quality.



SPECIAL SOLUTIONS

For special customer requirements, ALMiG offers project-based special solutions, e.g. for the marine sector, the railway sector or compressed air containers.





About

Started in Italy Since 40 years, trade mark PEI has been present on the international market resistance welders producing: Pedestal and pneumatic rocker arm spot welders, Bench spot welders, Seam welders and 3 phase d.c.

SPOT WELDING COLUMNS

- ROCKER ARM SPOT WELDERS
- LINEAR ACTION SPOT WELDERS
- PROJECTION WELDERS
- SEAM WELDERS
- BUTT WELDERS



SUSPENDED SPOT WELDING GUNS



TWIN SPOT WELDING GROUPS



Single side twin spot welders
Welding control on board



Twin spot portable spot welders
Welding control in separated cabinet

COIVER



About

This is our Italian partner for designing and fabricating of complete powder coating lines. The coating line includes coating booth, drying oven, curing oven and conveyors



LIQUID AND SPRAY PAINTING SYSTEMS

Liquid paint finishing is used to treat metal, wood and plastic objects. The materials used can be both water-soluble and solvent paints applied by spray or immersion mode. The Coiver company produces finishing booths built with extreme care to prevent dust and impurities from entering the system and compromising the final quality of the painted items.

ELECTROSTATIC POWDER COATING

Coiver, based in Lecco, specialises in the design and construction of electrostatic powder coating plant and machinery, characterised by excellent performance. These machines are, in fact, ideal for industrial painting on very large areas. The area of specialisation of the company is related to equipment and robots for painting, for which it designs and manufactures both standard instruments and equipment and those tailored to customer requests.

INDUSTRIAL OVENS: MANUFACTURE AND SET UP

Industrial ovens play a fundamental role within the industrial coating systems, since they allow the paint to dry. Coiver, Lecco, deals with the design and set up of structures for the de-watering and drying paint and those for the polymerisation of powders.

PAINT ROBOTS AND SPRAY GUNS

Each structure designed and built by the Lecco company, in fact, is fitted with the best equipment, selected from the most advanced technologies. From paint robots to spray guns: they are all designed to make the finishing on plastic and metal artefacts faster and more efficient whatever their size and intended use.

INE



About

INE SpA offers a wide and deep range of products supplying both filler material and machines. This is an unusual structure for companies of this size within the welding industry, where such an offering can only be sustained by multinationals.

WELDING MACHINES.

MULTIPROCESS.
MIG/MAG.
TIG.
MMA.
PLASMA CUTTING.
ARC AIR.



FILLER MATERIALS.

SMAW - STICK ELECTRODES.
GMAW - SOLID WIRE.
GTAW - TIG-CUT LENGTHS.
FCAW - CORED WIRES.
SAW - SUBMERGED ARC WIRES.
SUBMERGED ARC FLUXES.



The POWER To Be Your Best SUPPLIER



TISENG GROUP.



Head Office

4394 Rue Hamelin,
Laval, H7T 2B8
QC, Canada

Branches

SAUDI ARABIA - EGYPT - UAE
www.tiseng.com
email: info@tiseng.com
Mob: +966 50 611 2322